

(Natural Key B)

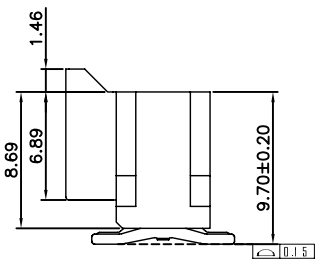

Natural Key B

Black Key A

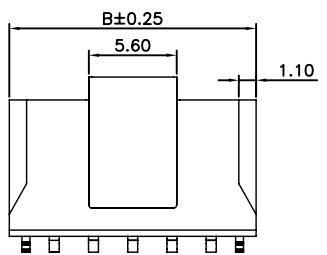
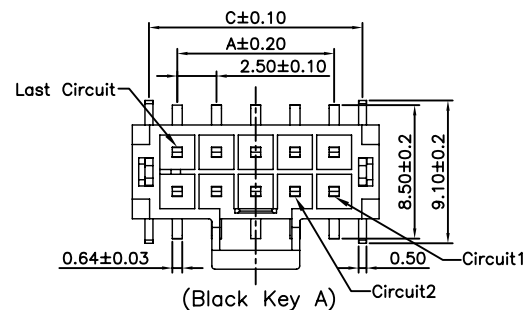
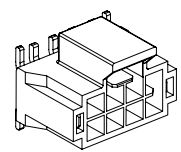
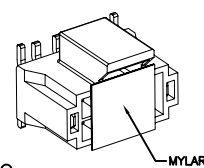
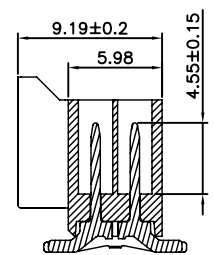
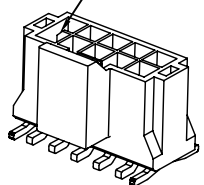
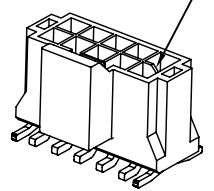

Specifications:
 Current Rating:6.5A AC,DC
 Voltage Rating:250V AC,DC
 Contact Resistance:10mohm Max
 Insulation Resistance:1000Mohm Min.
 Withstanding Voltage:1500V AC/minute
 Operating Temperature Range:-40°C~+105°C
 Material And Finish:
 Insulator:High Temp. Plastic(LCP UL94V-0)
 Insulator Color:Black
 Contact:Brass
 Plating:Tin Plated
 How To Order
 WFVSM25-XXX-X-LK-XX

- WH:White
- BK:Black
- LK:With Lock
- A:A Key(only Black)
- B:B Key(Only White)
- G:Gold Plated
- T:Tin Plated
- No. Of Positions
- VSM:Vertical SMT Type

Ordering Information&Dimensions

Circuits	Dimension(mm)			Circuits	Dimension(mm)		
	A	B	C		A	B	C
4	2.50	8.23	6.11	12	12.50	18.23	16.11
6	5.00	10.73	8.61	14	15.00	20.73	18.61
8	7.50	13.23	11.11	16	17.50	23.23	21.11
10	10.00	15.73	13.61	18	20.00	25.73	23.61

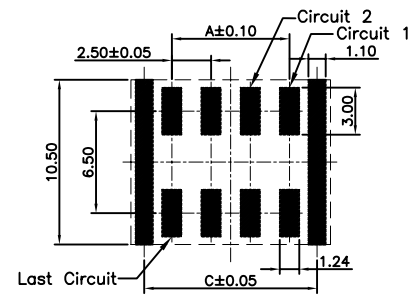

RECOMMENDED PCB LAYOUT
 THICKNESS=1.6mm MIN.

RoHS Compliant

F				DRAWN: Ken	GENERAL TOLERANCE: .X=±0.20 .XX=±0.15		DESCRIPTION: 2.5mm Wafer Vertical SMT Double Row SMT With Lock Type	SIZE A4
E								
D				CHECKED: Lily Chou	UNIT: MM	PART NO: WFVSM25-XXX-X-LK-XX		
C					SCALE: 1:1			
B				APPROVAL: Chao Peng	SHEET: 1 / 1			
A	20-Jul-2021	(PC0001)	Ken		PROJECTION:			
REV	DATE	FILE	BY					