

1

2

3

4

5

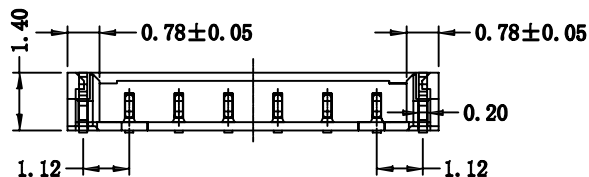
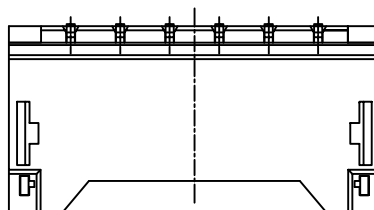
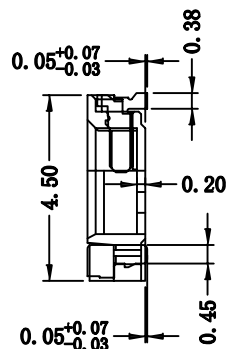
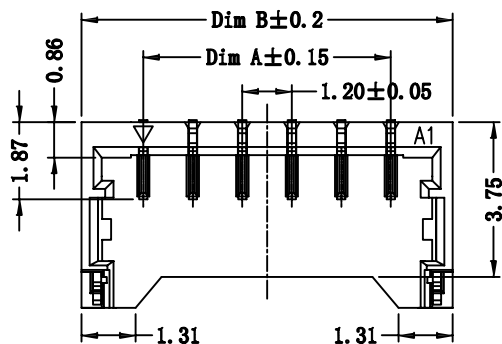
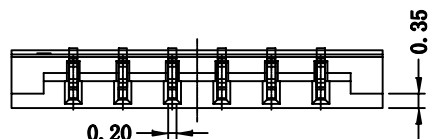

CKT.	DIM A	DIM B	CKT.	DIM A	DIM B
2	1.2	4.2	10	10.80	13.80
3	2.40	5.40	11	12.00	15.00
4	3.60	6.60	12	13.20	16.20
5	4.80	7.80	13	14.40	17.40
6	6.00	9.00	14	15.60	18.60
7	7.20	10.20	15	16.80	19.80
8	8.40	11.40	16	18.00	21.00
9	9.60	12.60			

Specifications:

Current rating:1.0A AC,DC

Voltage rating:125V AC,DC

Contact resistance:20m ohm.Max

Insulation resistance:100M ohm.Min

Withstanding voltage:250V AC/minute

Operating temperature range:-40°C~+85°C

Material:

Insulator:High Temp. Plastic(Nylon 6T UL94V-0)

Insulator Color:Beige

Contact:Brass

Plated:Gold Plated

How To Order:

WFRSM12-XXG

G:Gold Plated
No.Of Position
R/A SMT Type

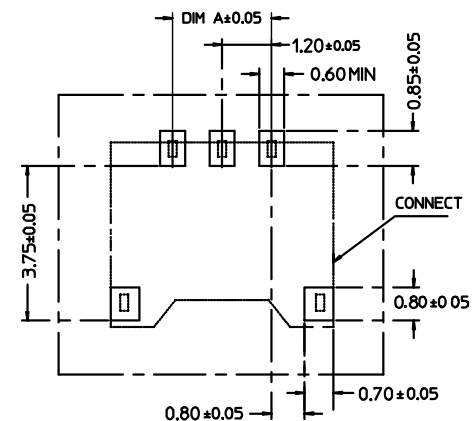
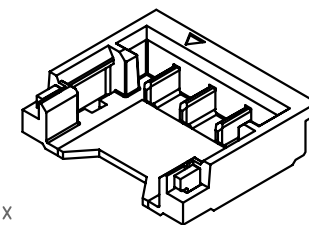

PCB LAYOUT

RoHS Compliant

F				DRAWN:	GENERAL TOLERANCE:
E				Ken	.X=±0.20
D				CHECKED:	.XX=±0.15
C				Lily Chou	UNIT: MM
B				APPROVAL:	SCALE: 1:1
A	14-Nov-2014	(H0050)	Ken	Chao Peng	SHEET: 1 / 1
REV	DATE	FILE	BY		PROJECTION:

Ken
Lily Chou
Chao Peng

GENERAL TOLERANCE:

.X=±0.20

.XX=±0.15

UNIT: MM

SCALE: 1:1

SHEET: 1 / 1

PROJECTION:

HOYATO
Connector supplies

东莞好亚通电子厂

DESCRIPTION:

1.2mm Wafer R/A SMT Type

PART NO:

WFRSM12-XXG

SIZE

A4