

1

2

3

4

5

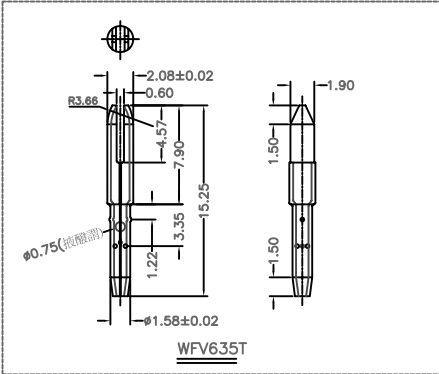
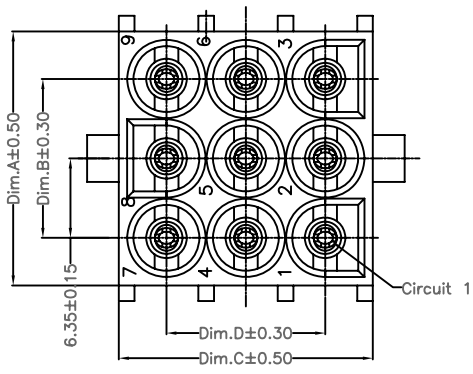
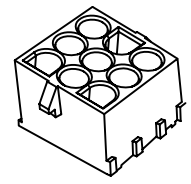

Specifications:  
 Current Rating:13.0 Amps  
 Voltage Rating:600V AC/DC  
 Contact Resistance:20m Ohm Max  
 Insulator Resistance:1000M Ohm Min  
 Withstanding Voltage: 5000V AC/Minute  
 Operating Temperature Range:-55°C To +105°C  
 Materials and Finish:  
 Insulator:Nylon 66 (UL94V-0)  
 Contact:Phosphor Bronze  
 Plating:Tin Plated

How To Order  
 WFPV635-XX-V0  
 V0 Type  
 No.of Positions  
 V: Straight

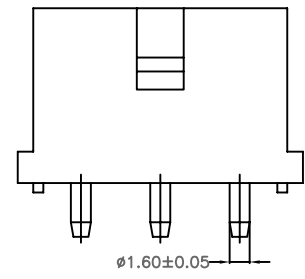
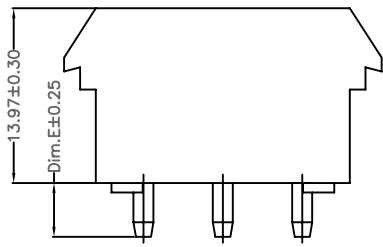

| Circuits | Dim.A±0.25 | Dim.B±0.15 | Dim.C±0.25 | Dim.D±0.15 | Dim.E±0.25 |
|----------|------------|------------|------------|------------|------------|
| 2        | 7.62       | —          | 13.97      | 6.35       | 4.30       |
| 3        | 7.62       | —          | 20.32      | 12.70      | 4.30       |
| 4        | 7.62       | —          | 26.67      | 19.05      | 4.30       |
| 5        | 7.62       | —          | 33.02      | 25.40      | 4.30       |
| 6        | 20.32      | 12.70      | 13.97      | 6.35       | 4.30       |
| 7        | 7.62       | —          | 45.72      | 38.10      | 4.30       |
| 8        | 7.62       | —          | 52.07      | 44.45      | 4.30       |
| 9        | 20.32      | 12.70      | 20.32      | 12.70      | 4.30       |
| 10       | 7.62       | —          | 64.77      | 57.15      | 4.30       |
| 12       | 20.32      | 12.70      | 26.67      | 19.05      | 4.30       |
| 15       | 20.32      | 12.70      | 33.02      | 25.40      | 4.30       |

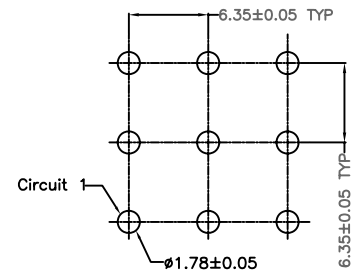

P.C.B. Layout

RoHS Compliant

|     |             |          |     |
|-----|-------------|----------|-----|
| F   |             |          |     |
| E   |             |          |     |
| D   |             |          |     |
| C   |             |          |     |
| B   |             |          |     |
| A   | 22-May-2014 | (PC0001) | Ken |
| REV | DATE        | FILE     | BY  |

DRAWN: Ken  
 CHECKED: Lily Chou  
 APPROVAL: Chao Peng

GENERAL TOLERANCE:  
 .X=±0.20  
 .XX=±0.15  
 UNIT: MM  
 SCALE: 1:1  
 SHEET: 1 / 1  
 PROJECTION:

DESCRIPTION:  
 6.35mm Power Wafer Straight Type  
 PART NO: WFPV635-XX-V0



SIZE  
**A4**

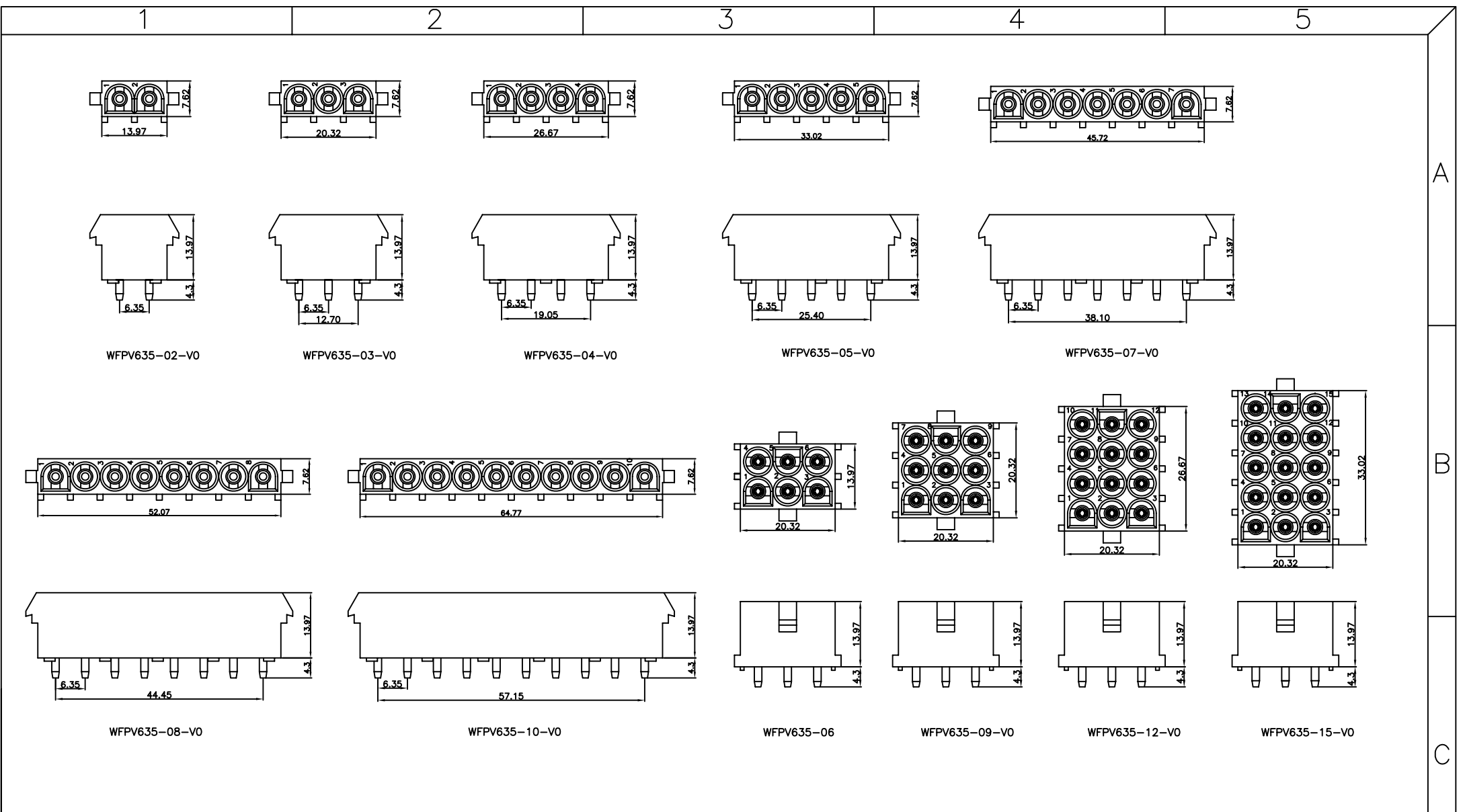

RoHS Compliant

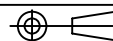
|     |             |          |     |           |   |   |                                  |      |
|-----|-------------|----------|-----|-----------|---|---|----------------------------------|------|
| F   |             |          |     | DRAWN:    | GENERAL TOLERANCE:  |  | DESCRIPTION:                     | SIZE |
| E   |             |          |     | Ken       | .X=±0.20<br>.XX=±0.15   |   |                                  |      |
| D   |             |          |     | CHECKED:  | UNIT: MM  | DESCRIPTION:  | 6.35mm Power Wafer Straight Type | SIZE |
| C   |             |          |     | Lily Chou | SCALE: 1:1  |   |                                  |      |
| B   |             |          |     | APPROVAL: | SHEET: 1 / 1  | PART NO:  | WFPV635-XX-V0                    | A4   |
| A   | 22-May-2014 | (PC0001) | Ken | Chao Peng | PROJECTION:  |   |                                  |      |
| REV | DATE        | FILE     | BY  |           |   |   |                                  |      |