

RoHS Compliant

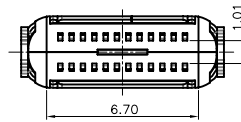
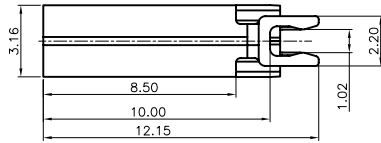
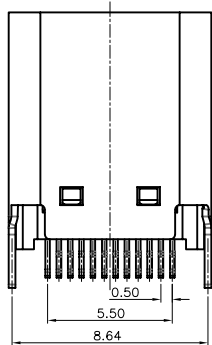
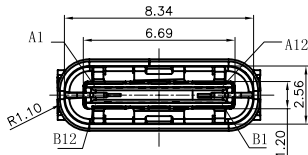
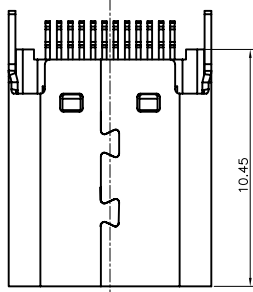

A1	GND	B12	GND
A2	SSTXP1	B11	SSRXP1
A3	SSTXN1	B10	SSRXN1
A4	VBUS	B9	VBUS
A5	CC1	B8	SBU2
A6	DP1	B7	DN2
A7	DN1	B6	DP2
A8	SBU1	B5	CC2
A9	VBUS	B4	VBUS
A10	SSRXN2	B3	SSTXN2
A11	SSRXP2	B2	SSTXP2
A12	GND	B1	GND
PIN	SIGNAL NAME	PIN	SIGNAL NAME

Specifications:

Current Rating:5.0A AC,DC
 Voltage Rating:100V AC,DC
 Contact Resistance:40M Ohm Max
 Insulation Resistance:100M Ohm Min
 Withstanding Voltage:100V AC/Minute
 Operating Temperature Range:-40°C to +85°C

Mechanical:

Mating Force:5~20N Max
 Unmating Force:8~20N Min
 Durability:10000 cycles Min

Materials:

Insulator:High Temp.Plastic (LCP UL94V-0)
 Contact:Brass
 Contact Plating:Gold Plated on Contact Area,
 Matte-Tin Plated on Solder Tail.
 Shell:Stainless Nickel 50u" Plated

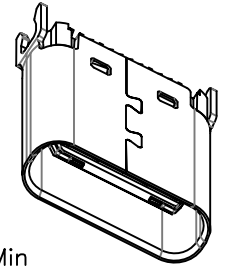

How To Order
 UBPO31-24SG-T10

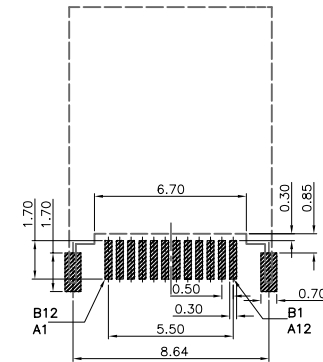
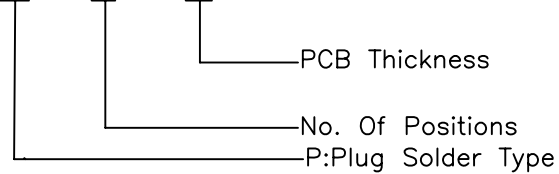

RECOMMENDED P.C.B. LAYOUT (T:1.00mm)
 TOLERANCE UNSPECIFIED ±0.05mm

E			
D			
C			
B	13-Jan-2016	(H0129)	Jack Zhou
A	05-Aug-2016	(H0129)	Jack Zhou
REV	DATE	FILE	BY

DRAWN: Jack Zhou	GENERAL TOLERANCE: .X=±0.2 .XX=±0.15
CHECKED: Ken Wang	UNIT: MM
APPROVAL: Make Hu	SCALE:2:1
	SHEET: 1 / 1
	PROJECTION:

DESCRIPTION: USB REV. 3.1 C Type Plug Conn PCB Thickness SMT Type		SIZE A4

