

USB Connector

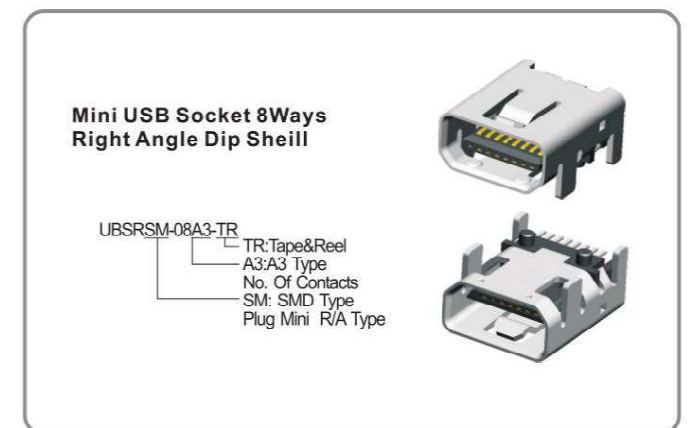

USB 3.0 Connector A Plug Right Angle SMD Type.

UBPARSM-09
No. Of Contacts
SM: SMD Type
A Type Plug
Right Angle

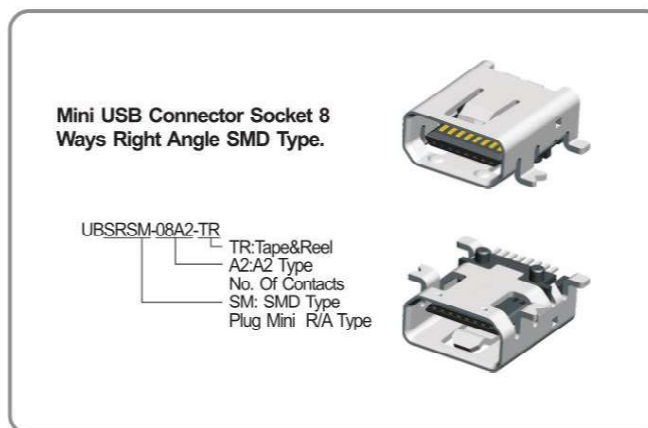
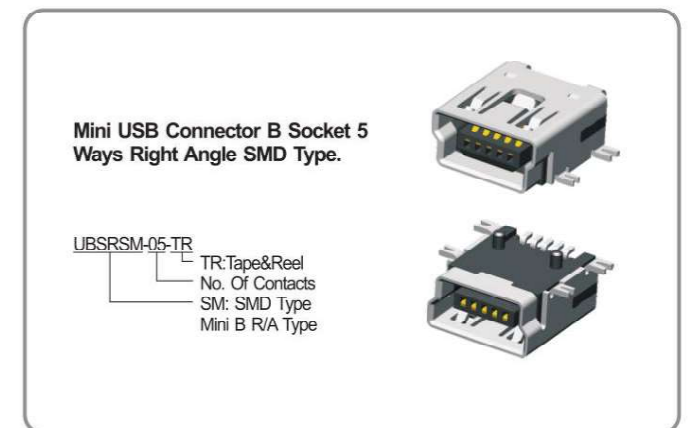
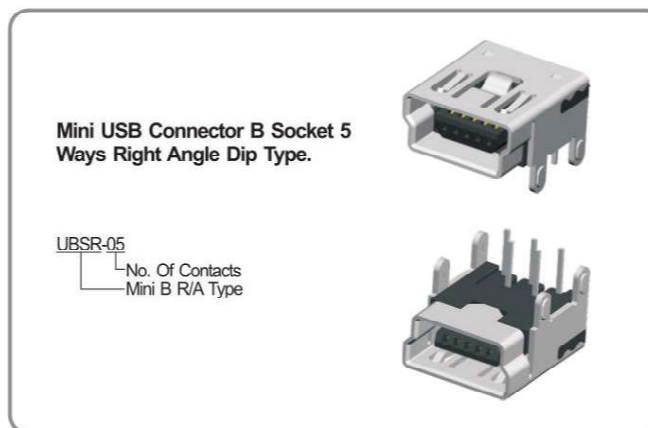
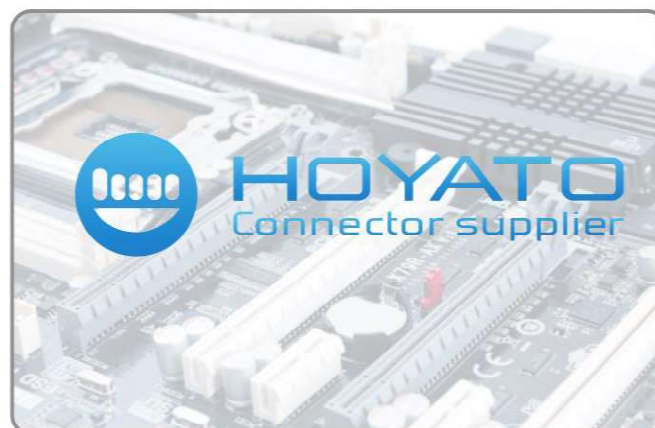
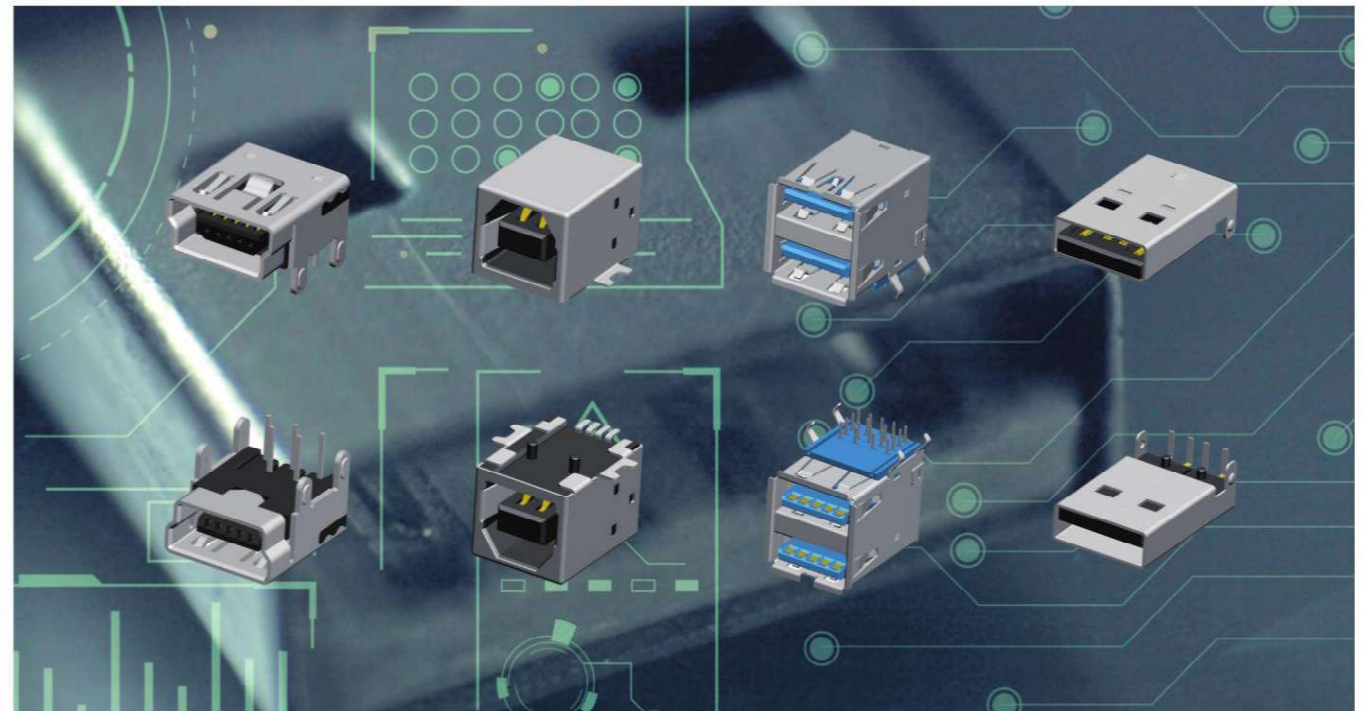

USB 3.0

USB 3.0 Connector A Socket Right Angle Dip Type.

UBSAR-09
No. Of Contacts
A Type Socket
Right Angle



USB 3.0

USB Connector A Socket Right Angle Dip Type.

UBSAR-04-XX
WH: White(Standard)
BK: Black
No. Of Contacts
A Type Socket
Right Angle



USB Connector A Socket R/A SMD Metal Shell Dip Type.

UBSARSM-04-XX
WH: White(Standard)
BK: Black
No. Of Contacts
SMD Type(Metal
Shell Dip Type)
A Type Socket R/A



USB 3.0 Rev. A Socket Right Angle Double

UBSAR-18
No. Of Contacts
A Type Socket
Right Angle

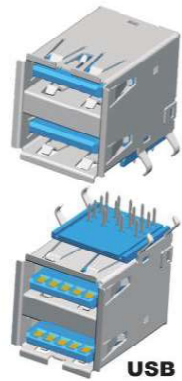

USB 3.0

USB Connector B Socket Right Angle Dip Type.

UBSBR-04-XX
WH: White(Standard)
BK: Black
No. Of Contacts
USB B Type
Right Angle

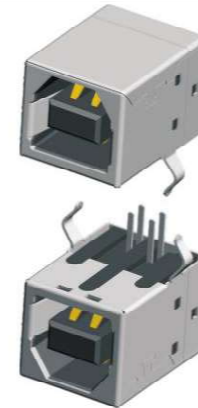

USB Connector A Socket 4 Ways Right Angle SMD Type.

UBSARSM1-04-XX
WH: White(Standard)
BK: Black
No. Of Contacts
SM1: SMD Type
A Type Socket R/A



USB Connector A Socket 8 Ways Dual Ports Right Angle Dip Type.

UBSAR-08-XX
WH: White(Standard)
BK: Black
No. Of Contacts
A Type Socket
Right Angle



USB Connector B Socket Straight Metal Shell Single Dip Type.

UBSBV-04-XX-XX
Blank: With Kink
K0: Without Kink
WH: White(Standard)
BK: Black
No. Of Contacts
USB B Type Straight

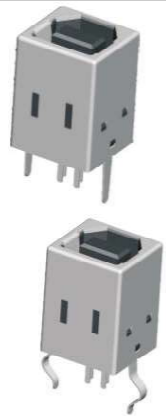

USB Connector B Socket Horizontal Connector SMD Type.

UBSBRSM-04-XX
WH: White(Standard)
BK: Black
No. Of Contacts
SM: SMD Type
USB B Type R/A

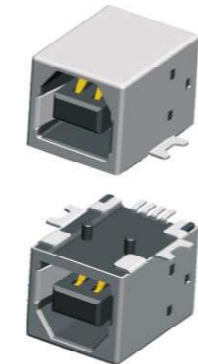

USB Connector A Plug 4 Ways R/A Dip Type.

UBPAR-04
No. Of Contacts
USB A Type Plug R/A



USB Connector A Plug 4 Ways Right Angle SMD Type.

UBPARSM-04-XX
BK: Black(Standard)
WH: White
No. Of Contacts
SM: SMD Type
USB A Type Plug R/A



USB Connector B Socket Vertical Connector SMD Type.

UBSBVSM-04-XX
WH: White(Standard)
BK: Black
No. Of Contacts
SM: SMD Type
USB B Type Straight

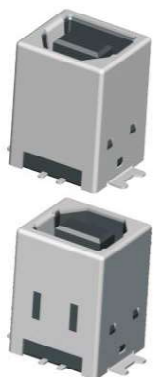

USB Connector A Socket Straight Dip Type.

UBSAV-04-XX
WH: White(Standard)
BK: Black
No. Of Contacts
A Type Socket
Straight



USB Connector A Plug 4 Ways Right Angle SMD Type.

UBPARSM1-04-XX
BK: Black(Standard)
WH: White
No. Of Contacts
SM1: SMD Type
USB A Type Plug R/A



USB 3.0 Rev. A Plug Solder Series

UBPAO-09-XX
BU: Blue BK: Black
No. of Contacts (9pin)
Plug Solder Type



USB 3.0

USB C 3.1 Rev. Plug Clamp Type Series



UBPO31-24SG-TXX
 T10: Board Thickness 1.0mm (0.8/1.6mm)
 No. of Contacts (24pin)
 Plug Solder Type

USB C 3.1 Rev. Plug Straight SMT Type Series



UBPV31-24SGXX
 5: Selective Gold 5u"
 15: Selective Gold 15u"
 30: Selective Gold 30u"
 No. of Contacts (24pin)
 Plug Straight Type

Mirco USB Waterproof SMT Type Series



MUBPRSM2-051P
 Waterproof
 No. of Contacts (5pin)
 Plug SMT R/A Type

USB 3.0 Rev. A Socket Double Row Solder Series



UBSAO-18-XX
 BU: Blue
 BK: Black
 No. of Contacts (18pin)
 Socket Solder Type

Mirco USB Waterproof SMT Type Series



MUBPRSM1-051P
 Waterproof
 No. of Contacts (5pin)
 Plug SMT R/A Type

USB C 3.1 Rev. Socket H3.45mm SMT+Dip Type Series



UBSR31H1-24SG-XX
 5: Selective Gold 5u"
 15: Selective Gold 15u"
 30: Selective Gold 30u"
 No. of Contacts (24pin)
 Socket R/A Type

USB C 3.1 Rev. Socket H1.9mm SMT+Dip Type Series



UBSR31-24SG-XX
 5: Selective Gold 5u"
 15: Selective Gold 15u"
 30: Selective Gold 30u"
 No. of Contacts (24pin)
 Socket R/A Type

1.00mm FPC/FFC Connector NON ZIF SMD Vertical Double



FPCVSM10-XX
 No. Of Contacts (3 To 30 Ways)
 1.0mm Vertical
 V: Straight Type
 VSM: Vertical

1.00mm FPC/FFC Connector NON ZIF Dip Double Contacts

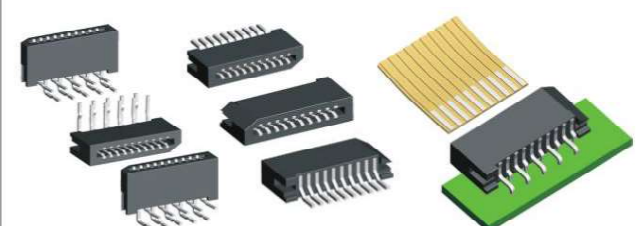

FPCRSM10-XX
 No. Of Contacts (3 To 30 Ways)
 1.0mm Horizontal
 R/R/A Type
 RSM: R/A SMT Type

USB C 3.1 Rev. Plug Sloder Board Series



UBPOB31-24-XX
 30: USB 3.0 Rve. Type
 20: USB 2.0 Rve. Type
 No. of Contacts (24pin)
 Plug Straight Type

USB C 3.1 Rev. Socket Waterproof SMT+Dip Type Series



UBSR31IPA-24SG-BK
 No. of Contacts (24pin)
 Waterproof
 Socket R/A Type

0.50mm FPC/FFC SMD Side Entry Top & Bottom Contact

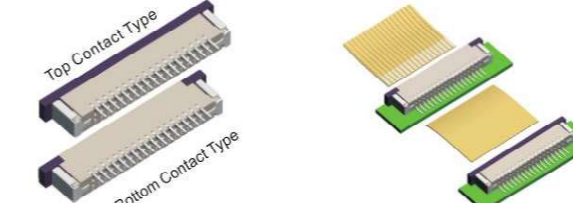

FPCRSM05-XX-XX
 BC: Bottom Contact Type
 TC: Top Contact Type
 No. Of Contacts (4 To 50 Ways)
 0.5mm R/A SMD Type

1.00mm FPC/FFC Connector NON ZIF Dip Single Contact

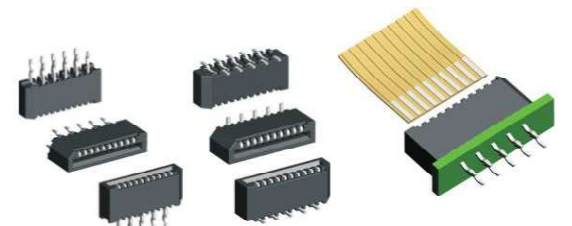

FPCVSM110-XX
 No. Of Contacts (3 To 30 Ways)
 V: Straight Type
 VSM: Vertical

Mirco USB AB Waterproof SMT Type Series



MUABPRSM-051P
 Waterproof
 No. of Contacts (5pin)
 Plug SMT R/AAB Type

PCB Jack +USB Socket Double R/A Type Series



RJDRMUBS-8P8C-LYRG
 Left LED Yellow
 Right LED Green
 No. of Contacts (8/10pin)
 USB Socket
 PCB JACK With Shielded

1.00mm FPC/FFC SMD Side Entry Top & Bottom Contact

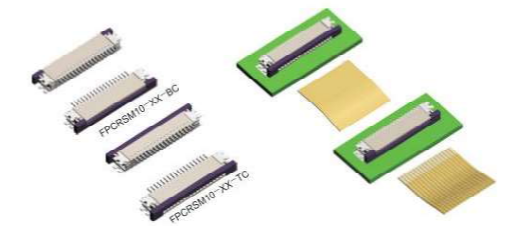

FPCRSM10-XX-XX
 BC: Bottom Contact Type
 TC: Top Contact Type
 No. Of Contacts (3 To 32 Ways)
 R/A SMD Type

2.54mm FPC/FFC Connector NON ZIF Double Contacts

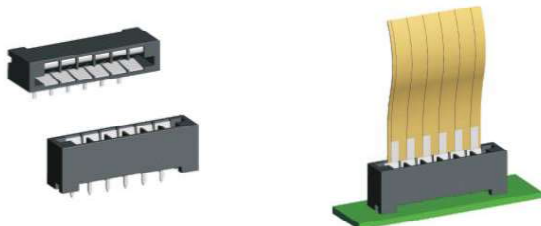

FPCV254-XX
 No. Of Contacts (3 To 30 Ways)
 V: 2.54mm Straight Type
 R: 2.54mm Right Angle Type